

# V34I EZL Nozzles



V34I  
EZL

VAPOR RECOVERY

## Automatic shut-off vacuum assist nozzle for full-service and self-service stations.

- V34I EZL nozzle shuts off when the gas tank is full.
- Stainless steel reinforced spout bushing keeps spout tip round, and acts as a captive fastener to prevent tip-end sensor damage.
- Nozzle is equipped with a unique Flo-Stop® device that shuts off the nozzle if it falls from the fill neck or raises above the horizontal.
- StreamShaper® reduces turbulence for straighter fuel flow and less splash back spillage.
- Tilt poppet design provides precise “to-the-penny” dispensing.
- Strong vapor valve in the nozzle that is mechanically operated by the on-off action of the nozzle’s lever.
- Husky® vapor return line is an internal part of the body casting, thus eliminating potential vapor leak points and fugitive evaporative emissions from the fuel remaining in the vapor path of the hose.
- Vapor assist achieved at the body end of the spout where a vapor ring catches emissions.
- Uses international spout and aluminum vapor collector.
- ADA-compliant EZ Lever reduces the force required to open the main poppet valve by 50%, resulting in a lever operating force ≤5 lbs.
- Nozzle comes standard with a full grip guard.
- Optional cold weather seals are rated to -40°F/C.
- Optional Gilbarco, Tokheim, and Wayne handguards can be fitted with a magnet to trigger the dispenser’s proximity switch, or can be provided without the magnet for dispensers equipped with a standard “flapper” switch.
- Optional vapor insert increases the vapor back pressure, closely matching that of the competition, and making installation a breeze, with little-to-no changes to the vacuum pump draw.
- Optional sightglass provides a clear window for the customer to view the fuel as it passes through the main poppet valve.



MODEL NO.  
13787223N^

### New Unleaded PHG Nozzles

MODEL NO.	DESCRIPTION	SHIPPING WEIGHT LBS (KG)
13787223N^	with Two Notch Hold Open Clip and Aluminum Vapor Collector	3.3 (1.5)

^ NOT LISTED

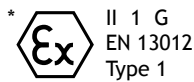

WARNING: Cancer and Reproductive Harm - www.P65Warnings.ca.gov



# V34I EZL Nozzles

Automatic shut-off vacuum assist nozzle for full-service and self-service stations.

## Dimensions

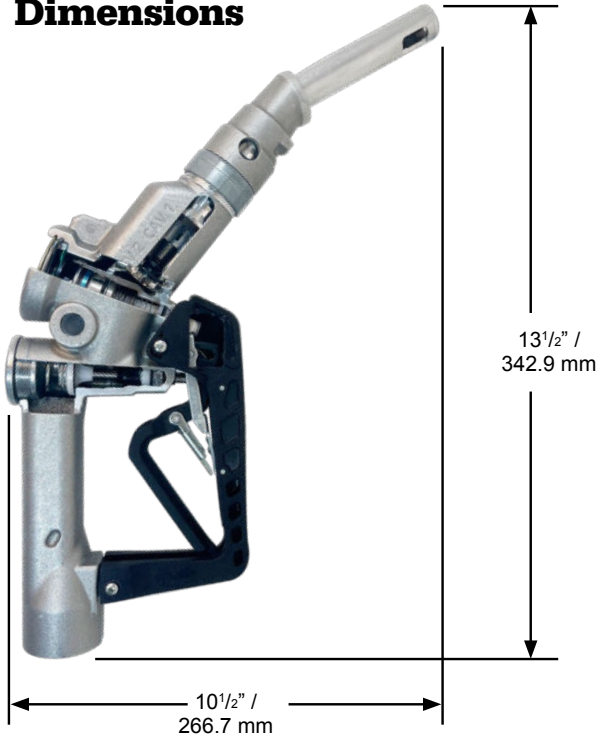

## Construction

Body	One piece sand cast aluminum with high-impact polymer handguard
Seals	Fluorocarbon
Packing	Double o-ring seal protected by fiber-reinforced Teflon®
Lever	Two piece polymer EZ Lever
Inlet	M34 x 1.5mm

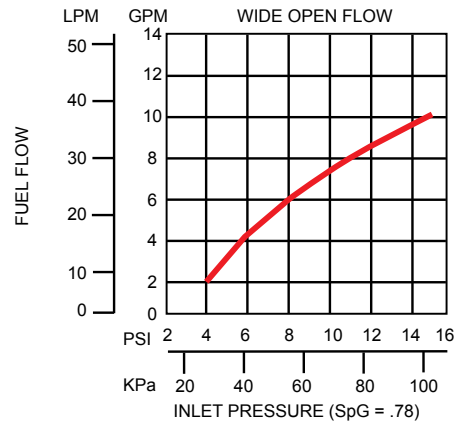
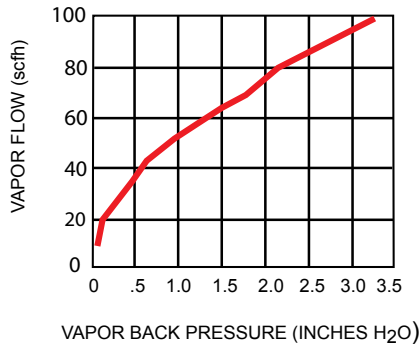
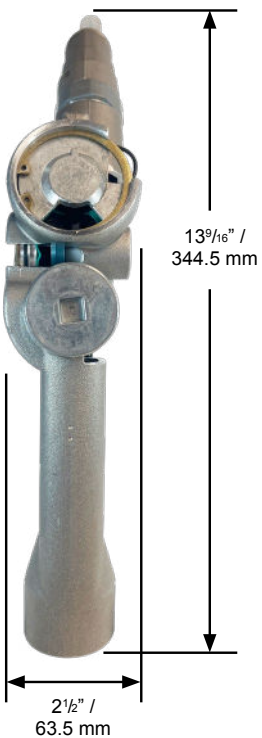



# V34I EZL Nozzles

Automatic shut-off vacuum assist nozzle for full-service and self-service stations.

## Nozzle Options

### Nozzle Guard Options



### Waffle Guard Options

1808 Waffle Guard



### TUV Vapor Insert

07329



### Handguard Options

Standard Polymer Handguard    Gilbarco Polymer Handguard (with or without Magnet)    Tokheim Polymer Handguard (with or without Magnet)    Wayne Polymer Handguard (with or without Magnet)



### Lever Options

Lever without Hold Open Clip

Lever with Hold Open Clip

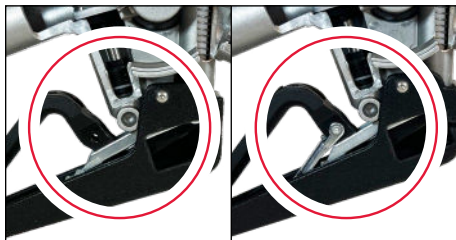

### Latch Plate Options

1 - Position Latch Plate

2 - Position Latch Plate

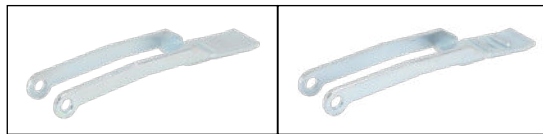

### Sightglass Option





# V34I EZL Nozzles

Automatic shut-off vacuum assist nozzle for full-service and self-service stations.

## System Options

### Safe-T-Breaks®

MODEL NO.	DESCRIPTION
004034	Reconnectable Safe-T-Break®
004034A*	Reconnectable Safe-T-Break® - Atex
005134A*	Non-Reconnectable Safe-T-Break® - Atex
006210	Non-Reconnectable Safe-T-Break®
008332	MAGBREAK® Coax M34 CK
010513	Non-Reconnectable Safe-T-Break® - Shearpin

### Spouts

MODEL NO.	DESCRIPTION
006291	V34 Spout Assy Kit (Includes 004000 VSG and 006391 Spout Assembly)
006391	V34 Spout Assembly with Streamshaper®

### Pressure/Vacuum Vents

MODEL NO.	DESCRIPTION
004620	2" Slip-On Pressure Vacuum Vent
004885	2" Thread-On Pressure Vacuum Vent - NPT
005885	2" Thread-On Pressure Vacuum Vent with Internal Screen - NPT

### Accessories, Testing and Maintenance

MODEL NO.	DESCRIPTION
000397	Unleaded Spout Gauge
003593	Hold Open Clip Kit
004335	O-ring, Air / Liquid Test Spout Adaptor
004360	Air / Liquid Spout Adaptor
005233	O-ring Kit
005260	Tool for dry Air / Liquid Test
005837	Vapor Assist Flo-Equalizer®
006941	Hose Conversion Adaptor M34 x 1.5
007089	Nozzle Service Kit

### Swivels

MODEL NO.	DESCRIPTION
004605	Multi-Plane Swivel
004605A*	Multi-Plane Swivel - Atex

### Guards

MODEL NO.	DESCRIPTION
004231	Full Grip Reguard
006628	POPD® S Clear Cover
006660	POPD® S Full Grip Guard
006951	Full Grip Guard
007220	POPD® S Full Grip Reguard
007999	POPD® H Clear Cover
008184	POPD® H Full Grip Guard
008191	POPD® H Full Grip Reguard
010089	Black Handle Cover
014526	Mate Guard

### Guard Color Chart

COLOR	SUFFIX	COLOR	SUFFIX	COLOR <i>CUSTOM</i>	SUFFIX
Blue	-01	Gold	-08	Amoco Blue	-07 <i>CUSTOM</i>
Red	-02	Silver	-09	Apple Green	-18 <i>CUSTOM</i>
Green	-03	BP Green	-16	Purple	-19 <i>CUSTOM</i>
Black	-04	M Blue	-25	Pink	-20 <i>CUSTOM</i>
Yellow	-05	Orange	-39	BPS Green	-22 <i>CUSTOM</i>
White	-06				

Scuff Guards are to be ordered with the corresponding guard color option added to the model number. Example: If BLUE guards are desired, add guard color option -01 to the model number (159504-01). For custom colors, a minimum order of 4,000 guards will be required.



2325 Husky Way • Pacific, MO 63069  
(800) 325-3558 • Fax (636) 825-7300  
[www.husky.com](http://www.husky.com) • [sales@husky.com](mailto:sales@husky.com)

MADE IN THE U.S.A.